



# SCALA2



<http://qr.grundfos.com/i/scala2install>

be  
think  
innovate

**GRUNDFOS** 



PN10:  
Max. 10 bar/1.0 MPa



- Voltage
- Ambient temperatur



Min./Max.  
0 °C - + 45 °C/  
32 °F - + 113 °F

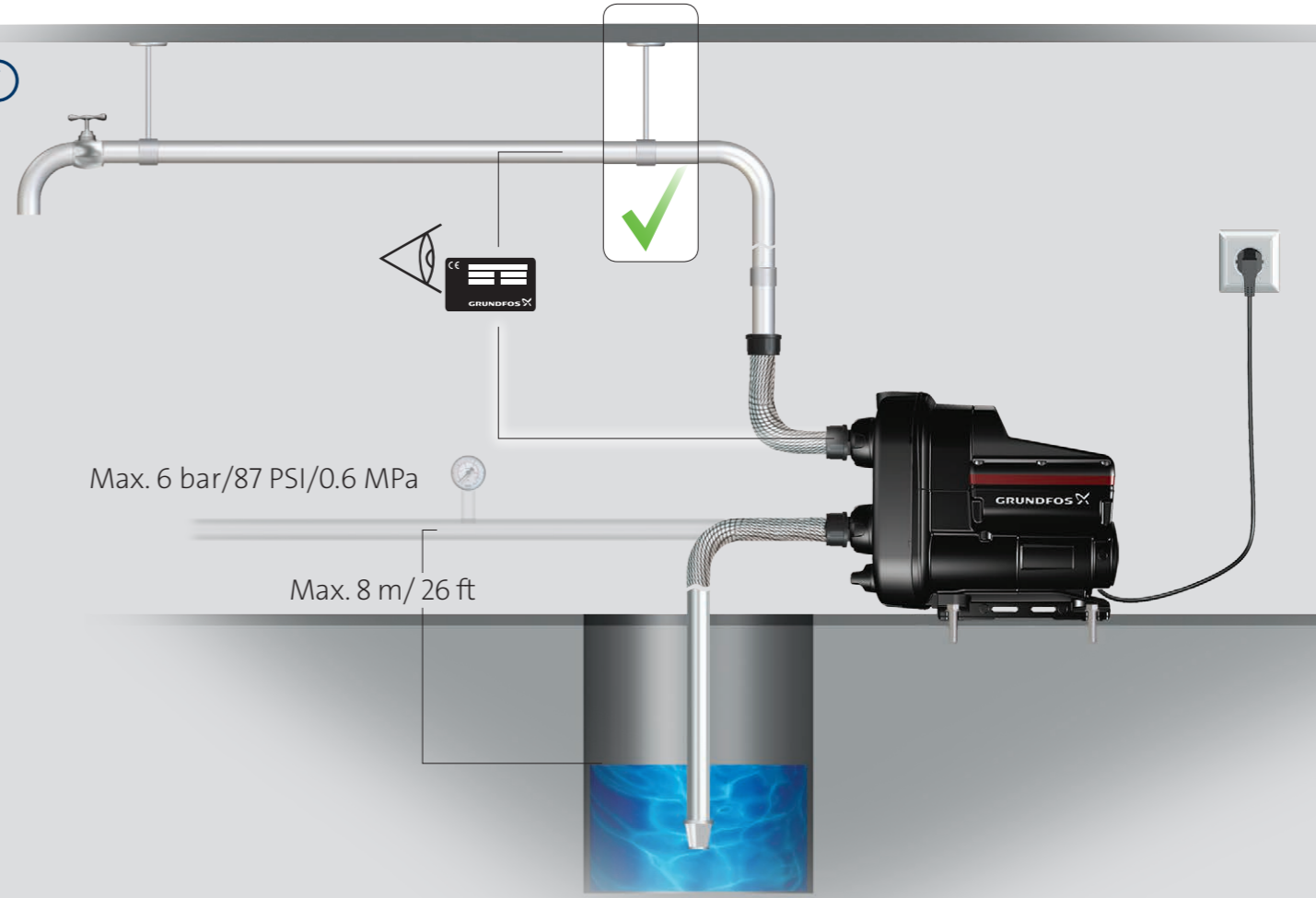
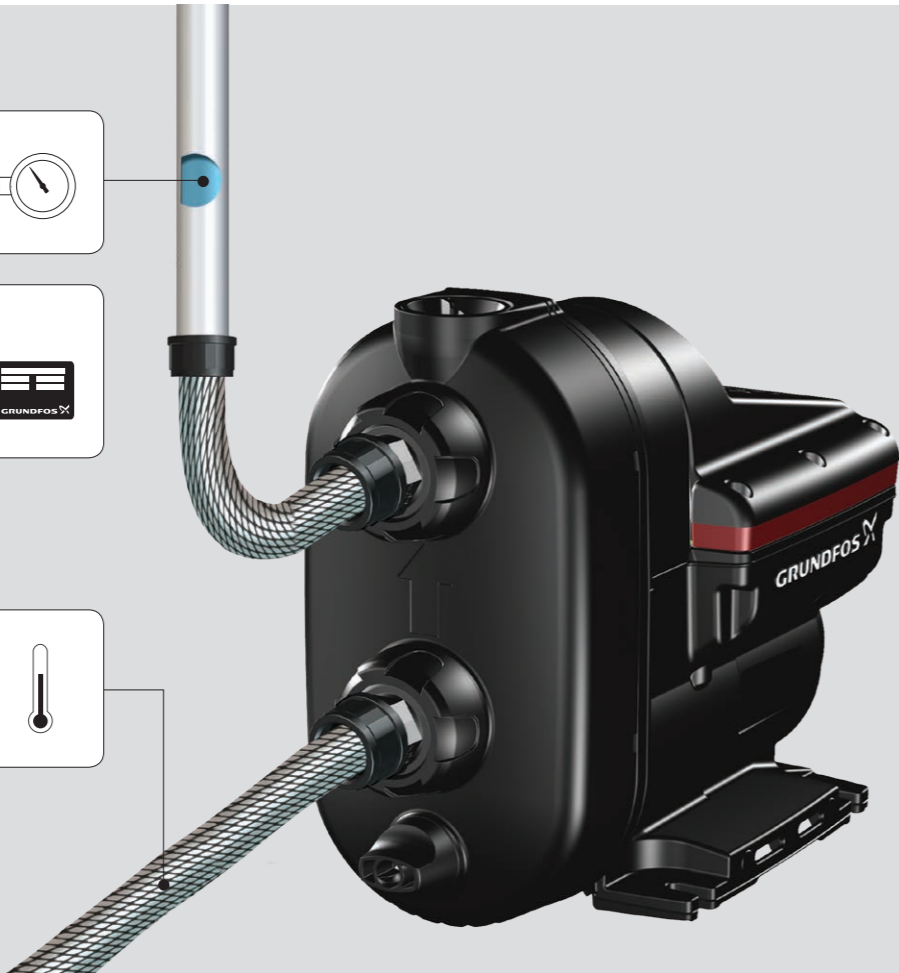

Max. 6 bar/87 PSI/0.6 MPa

Max. 8 m/ 26 ft

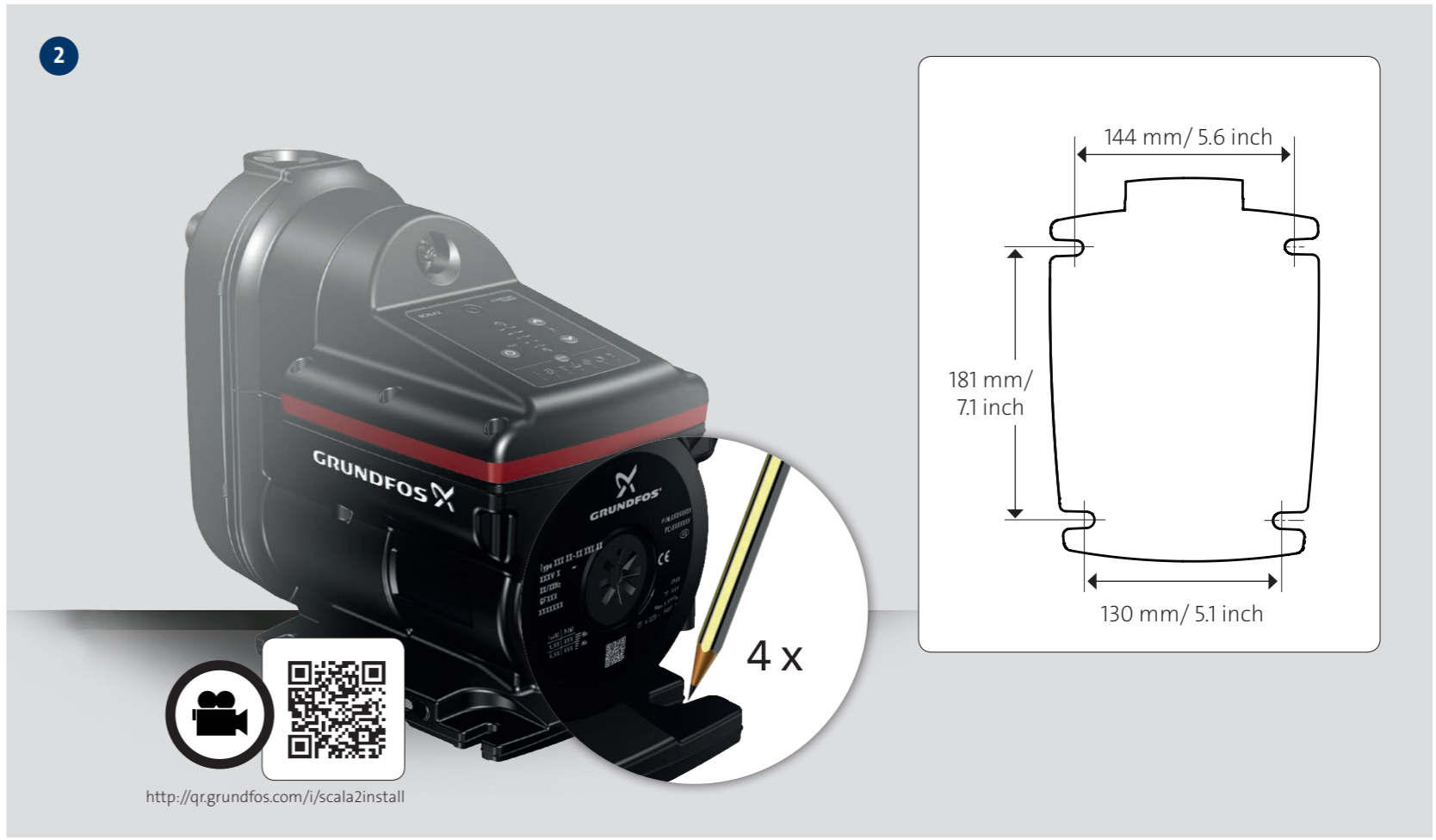
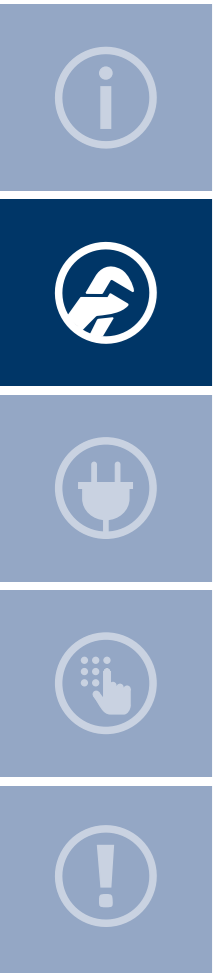

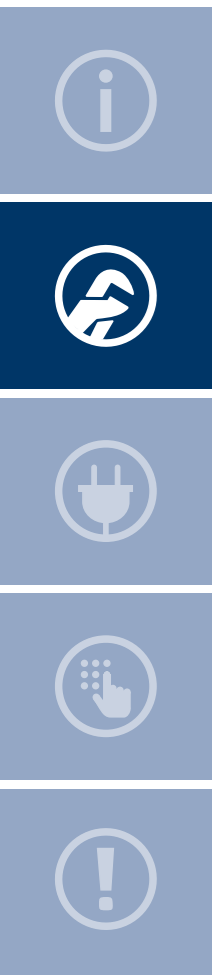

3

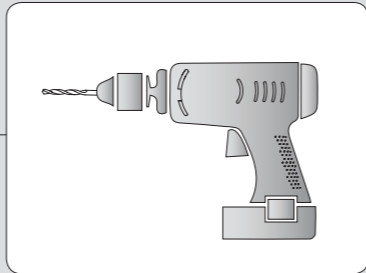

4 x

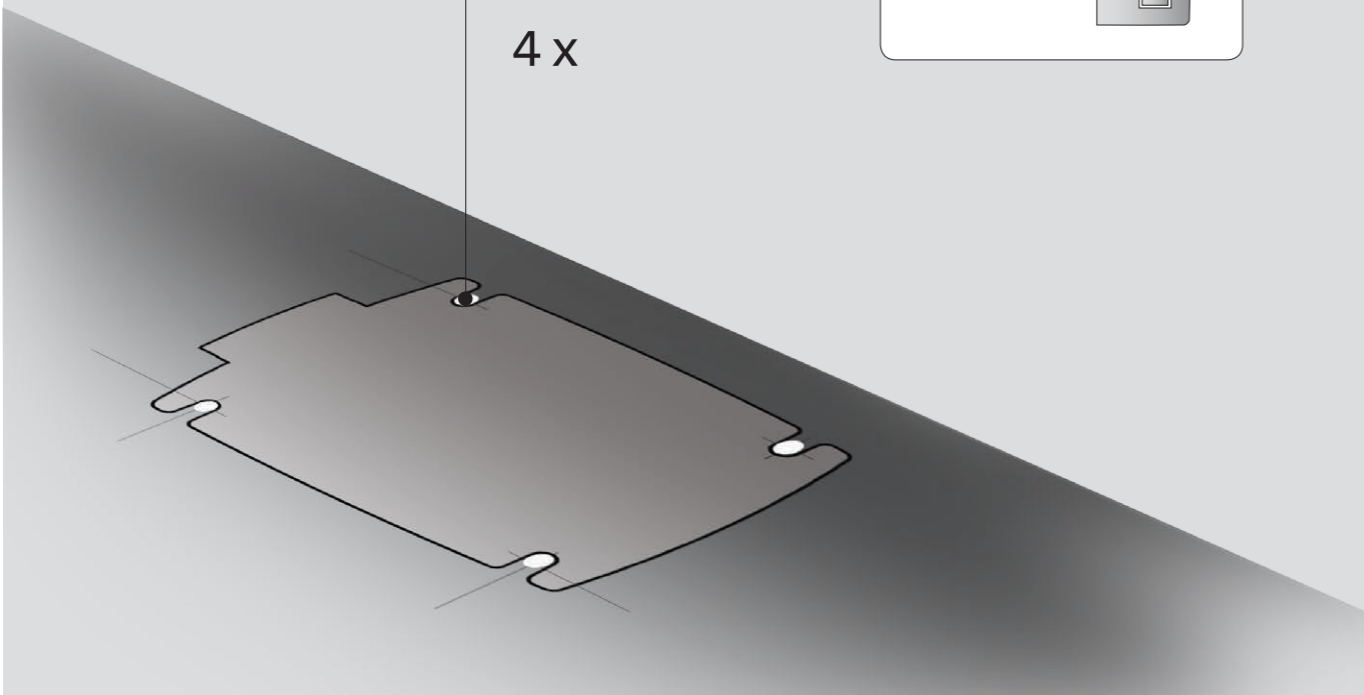

4

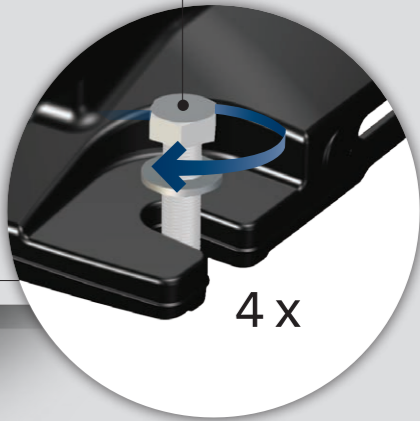
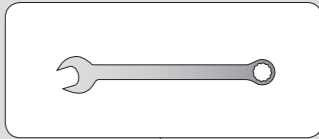

4 x

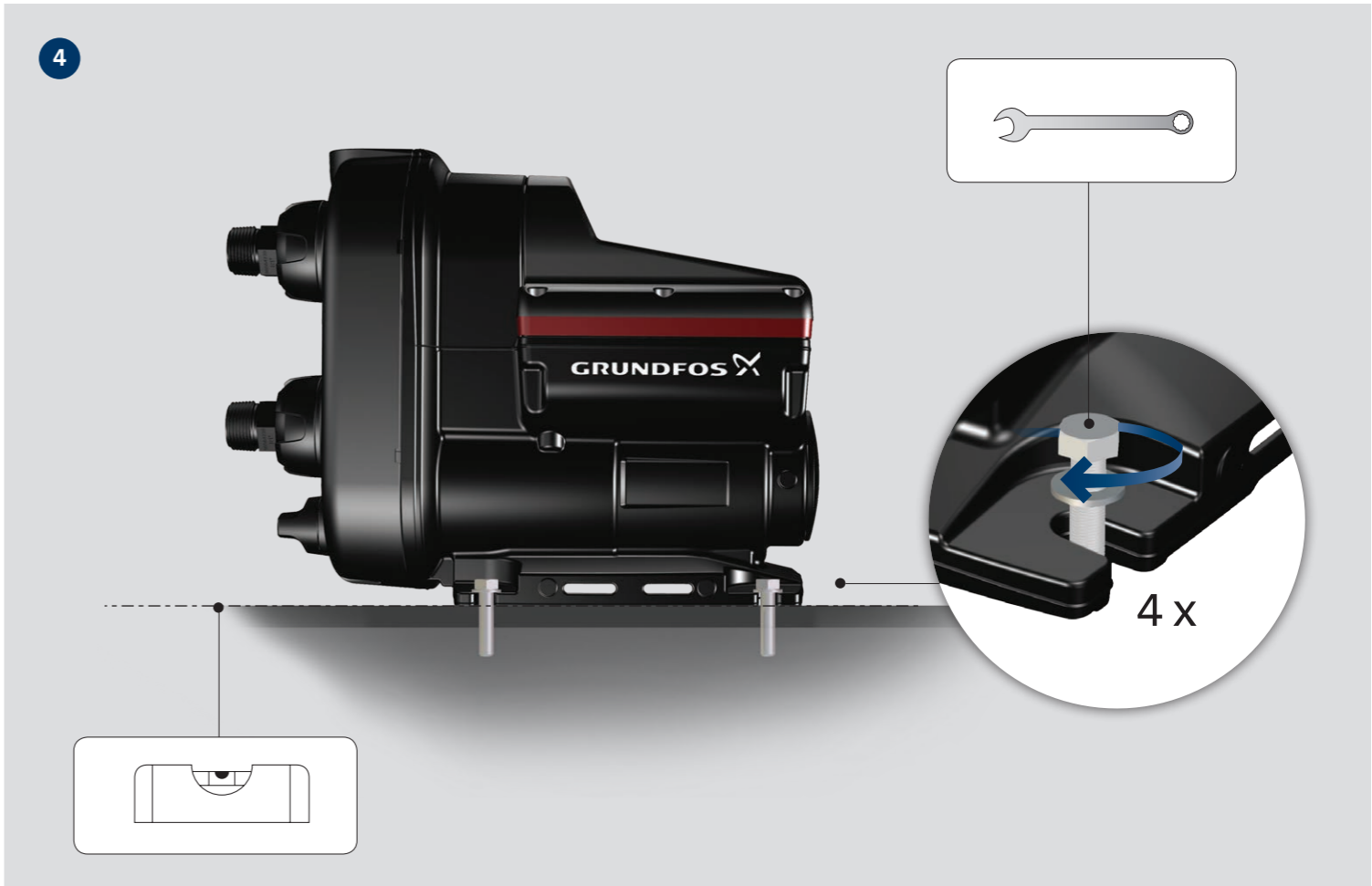
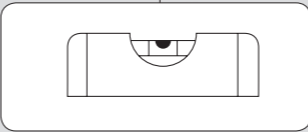

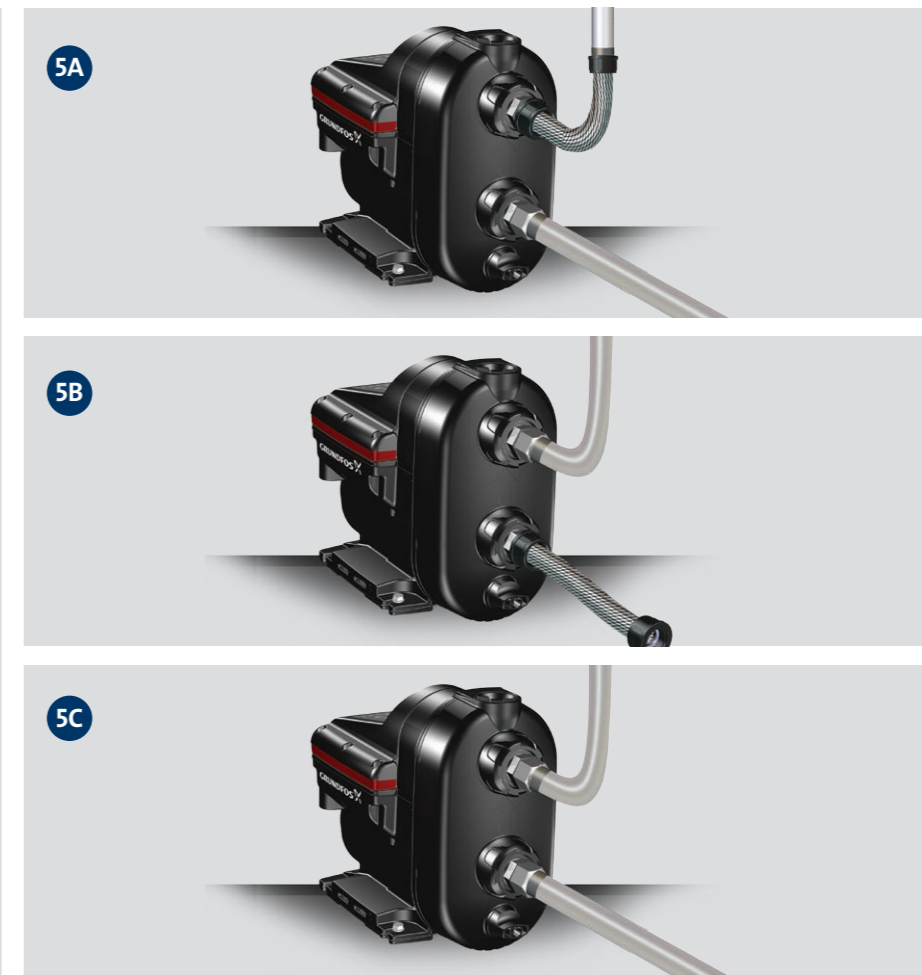
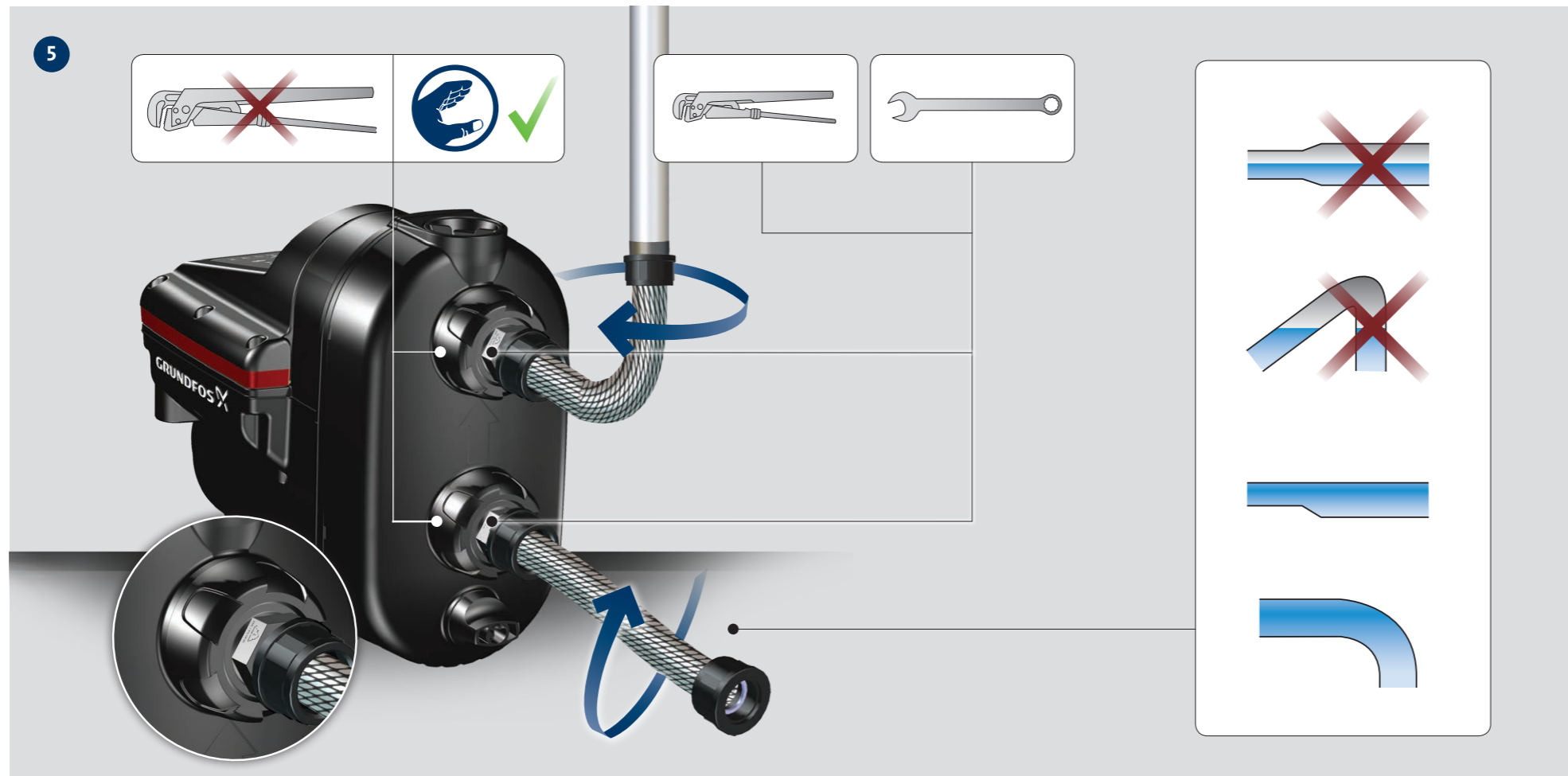
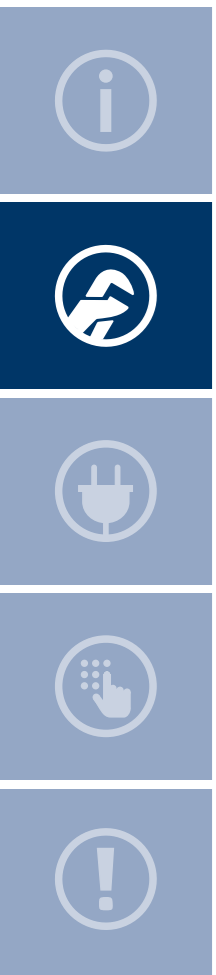

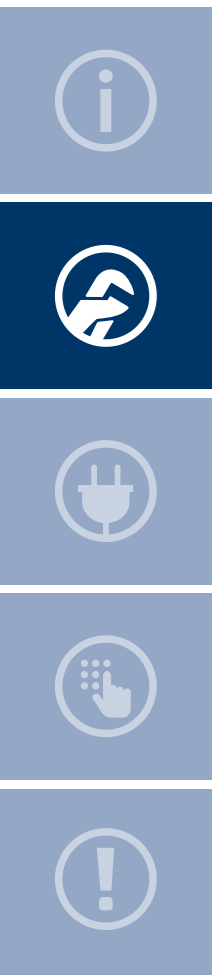

6

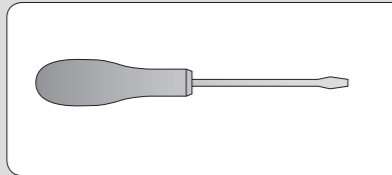

<http://qr.grundfos.com/i/scala2install>

7



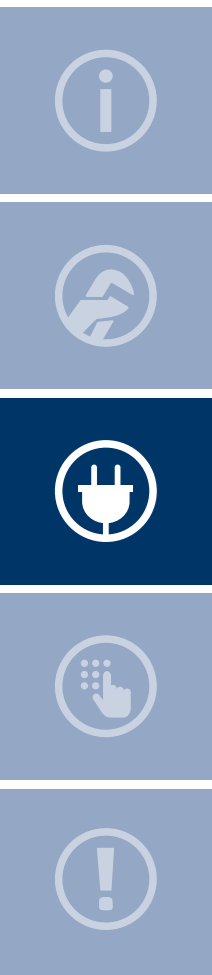

8

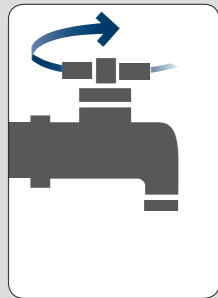

9

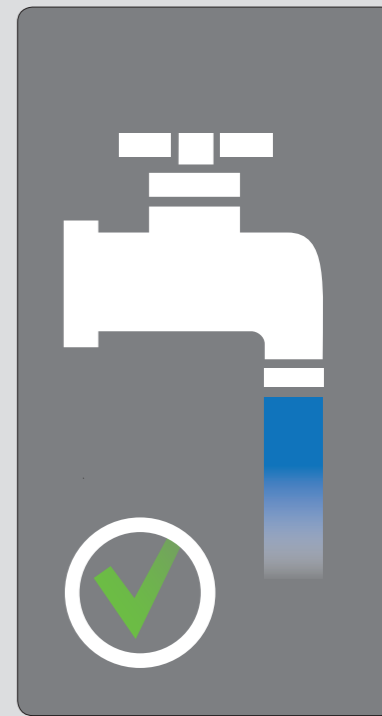

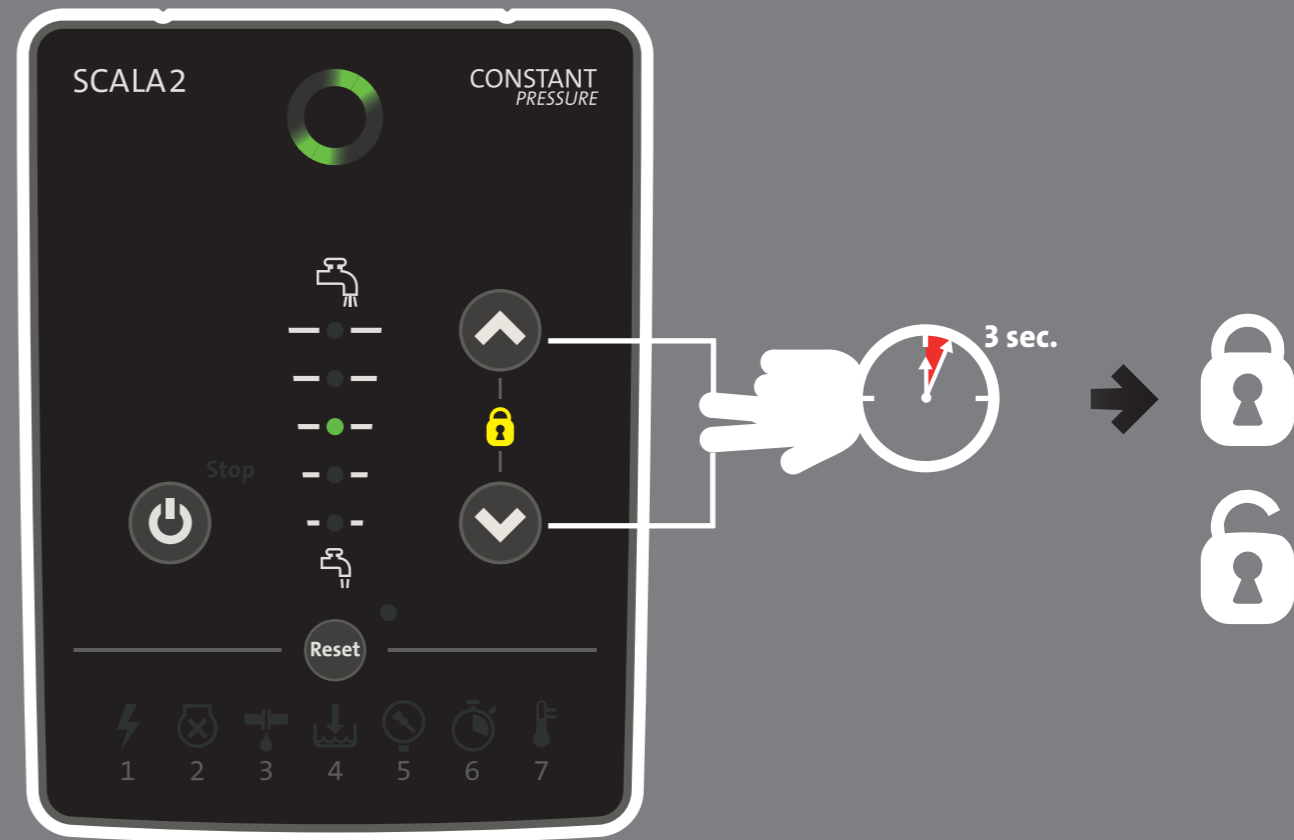
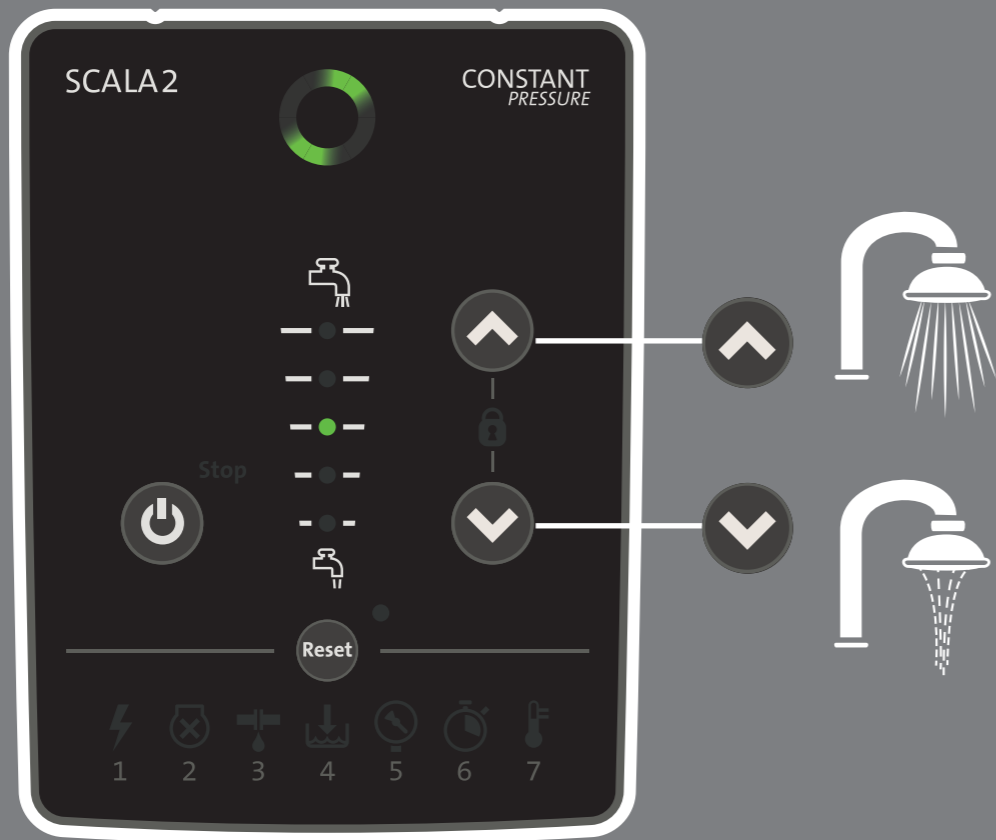
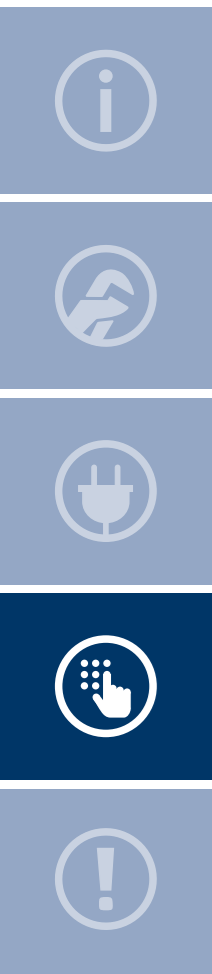



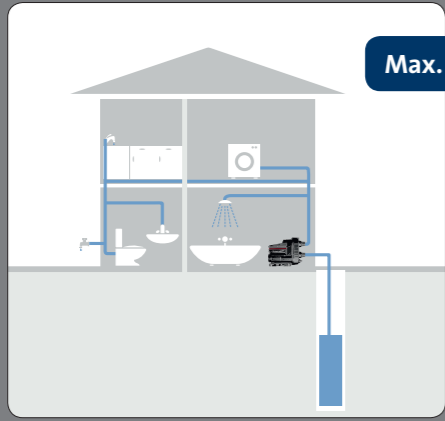
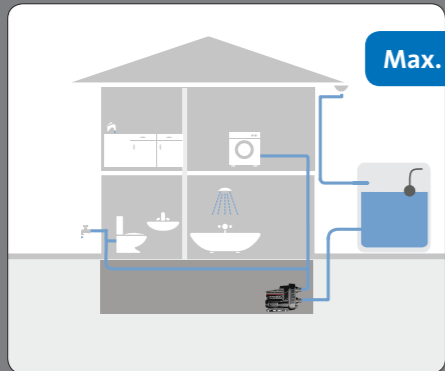
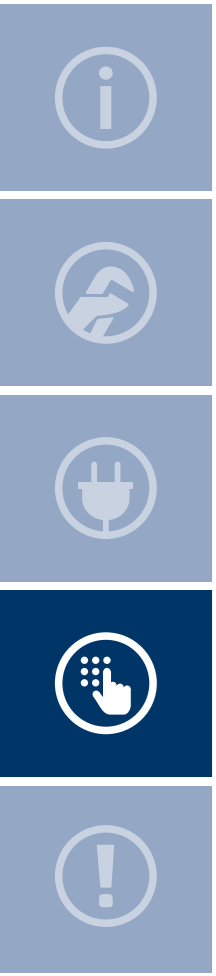

	BAR	PSI	Water colum [m] / [ft]	kPa	MPa
— ● —	5.5	80	55/180	550	0.55
— ● —	5.0	73	50/165	500	0.50
— ● —	4.5	65	45/150	450	0.45
— ● —	4.0	58	40/130	400	0.40
— ● —	3.5	51	35/115	350	0.35
— ● —	3.0	44	30/100	300	0.30
— ● —	2.5	36	25/80	250	0.25
— ● —	2.0	30	20/65	200	0.20
— ● —	1.5	22	15/50	150	0.15

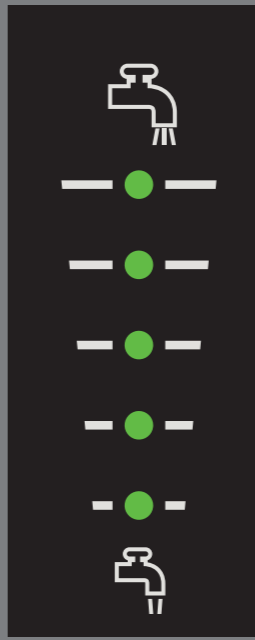
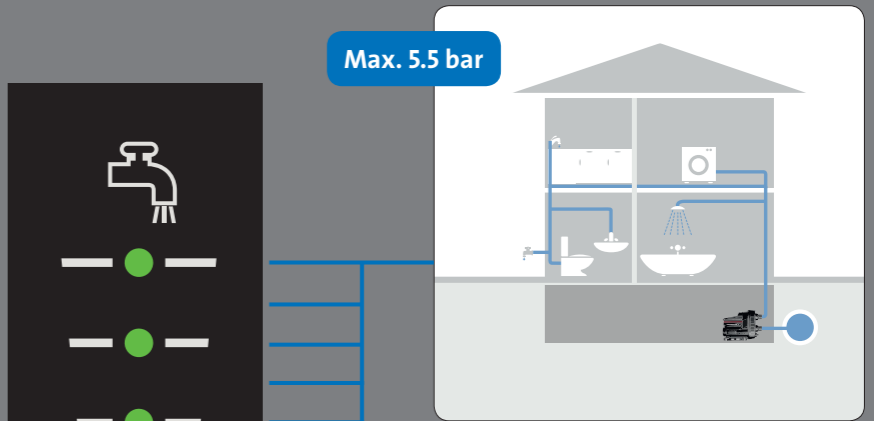

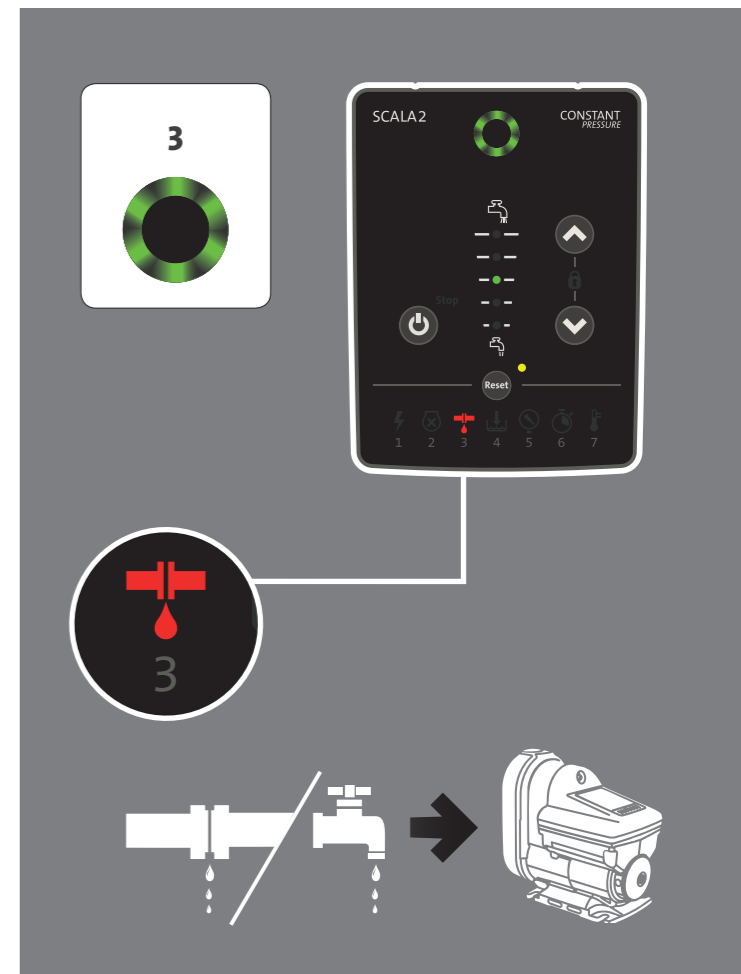
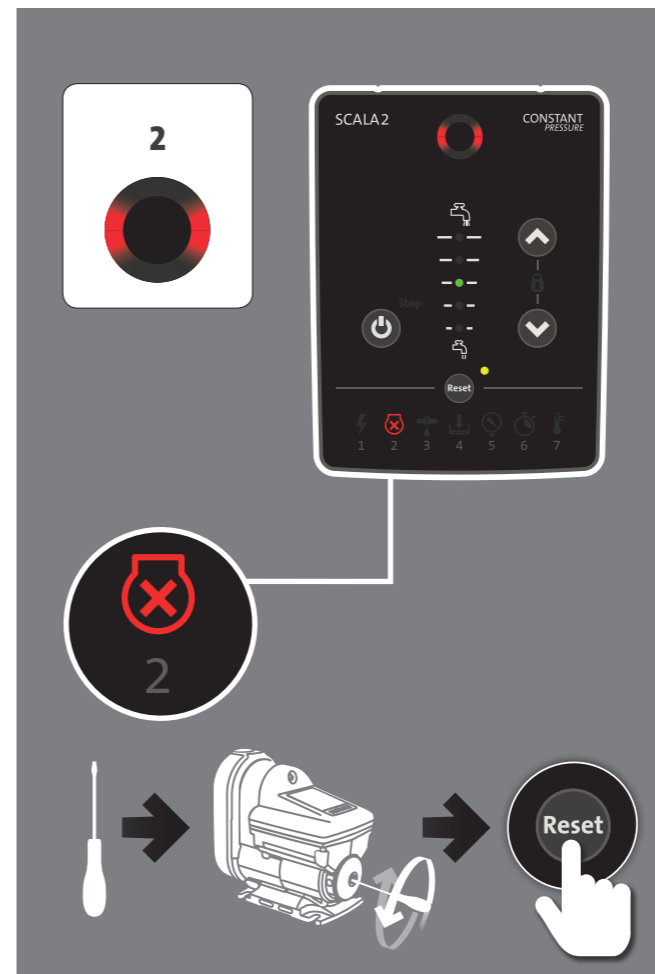
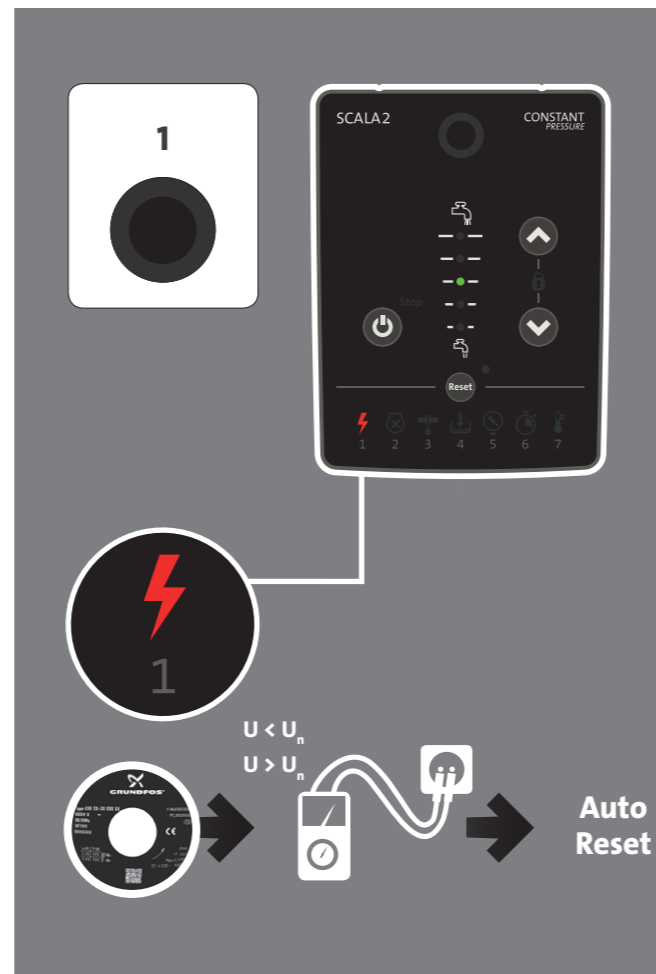
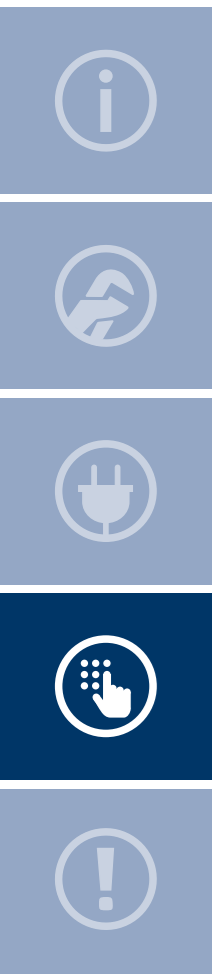

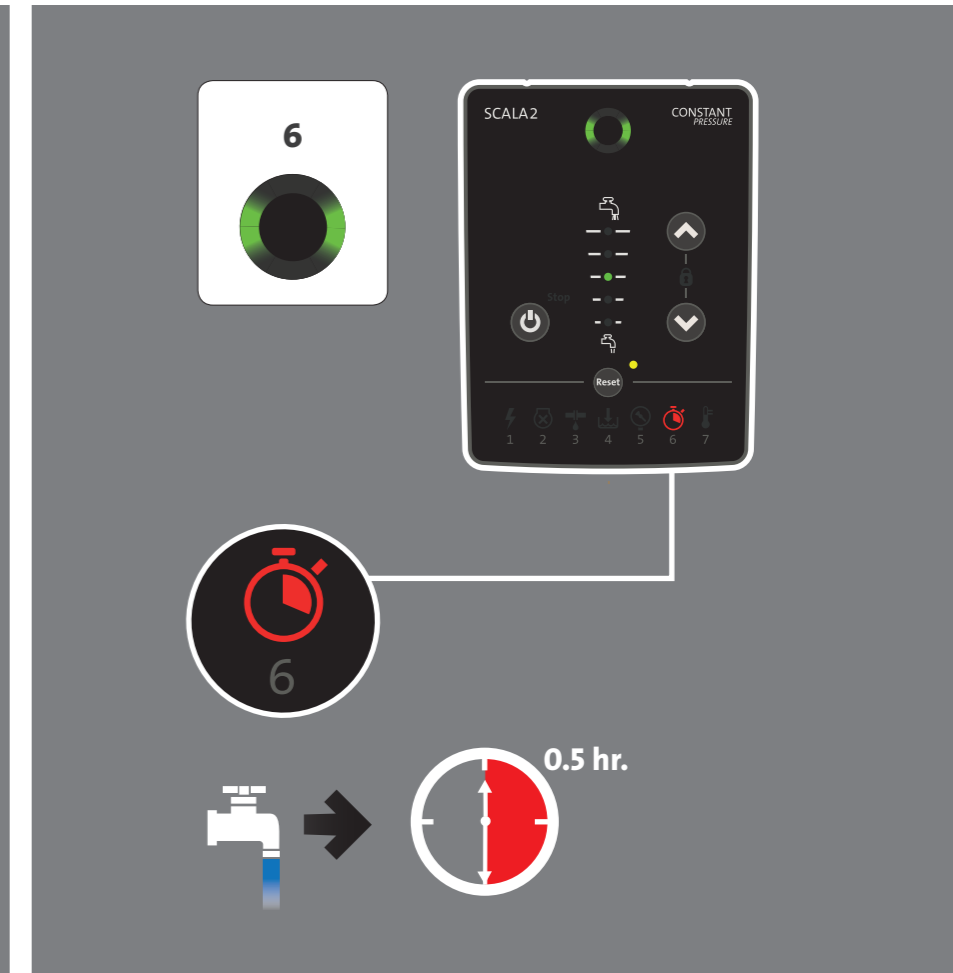
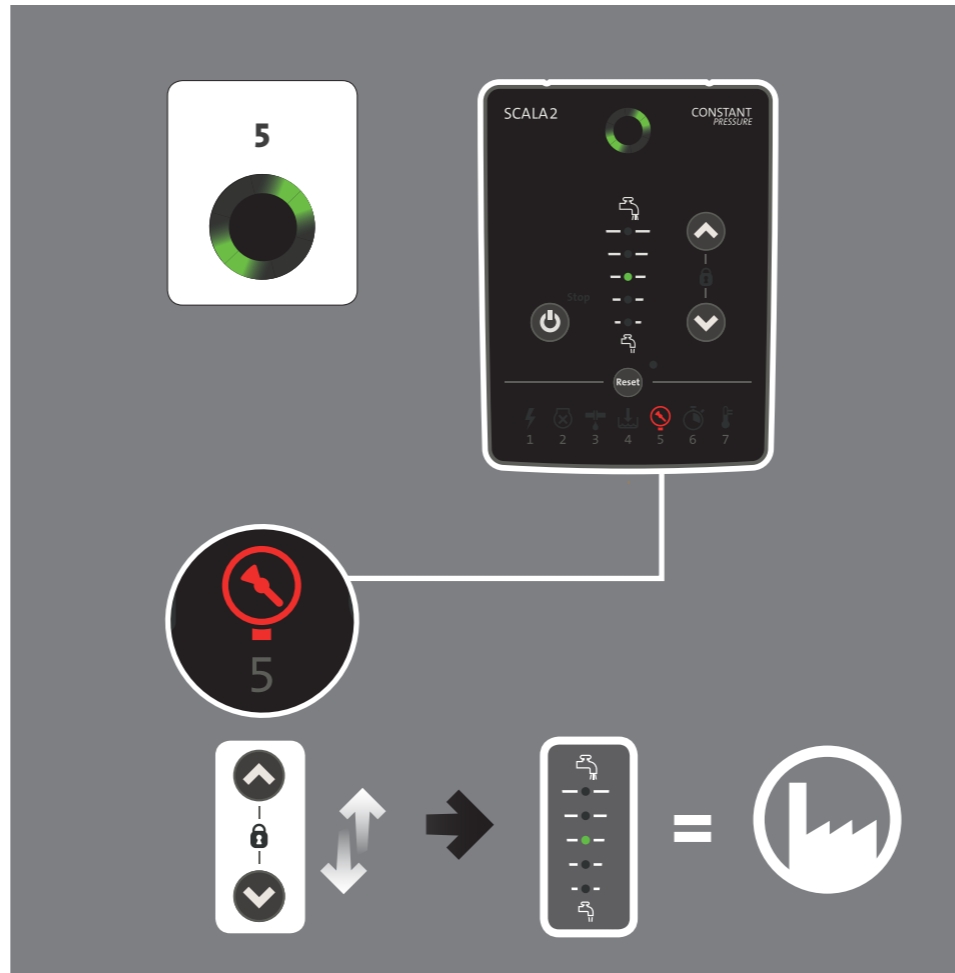
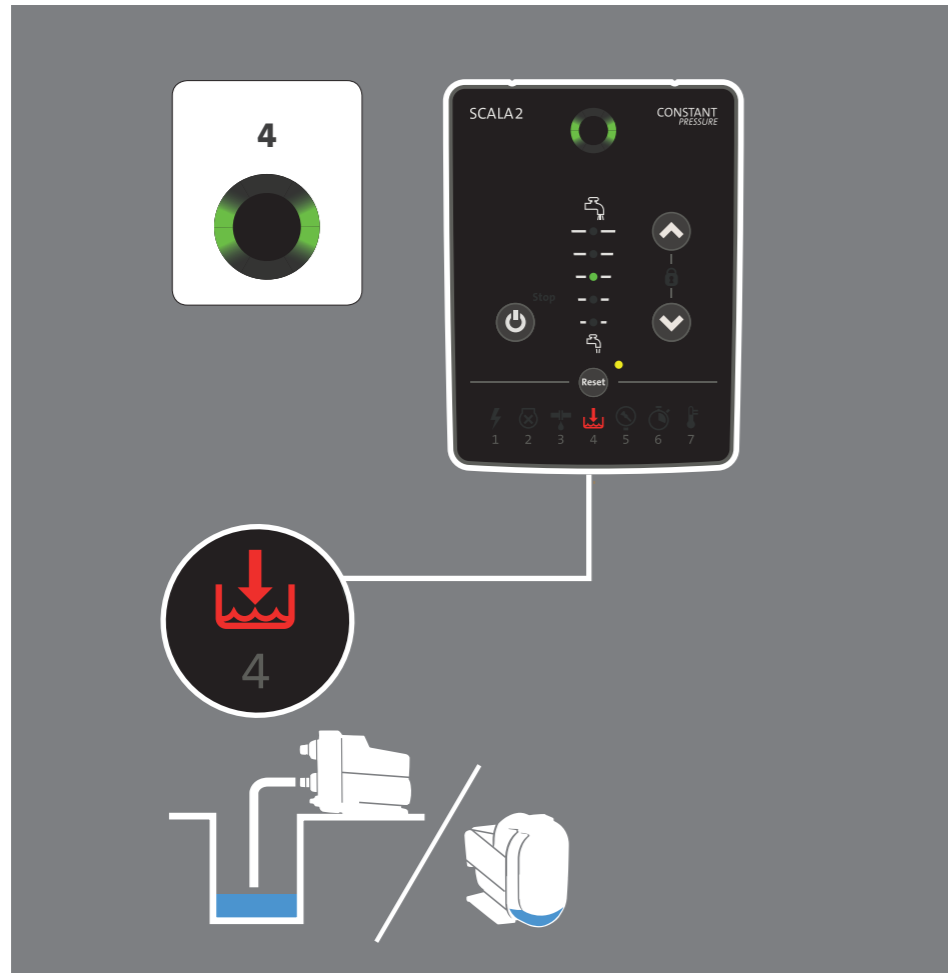
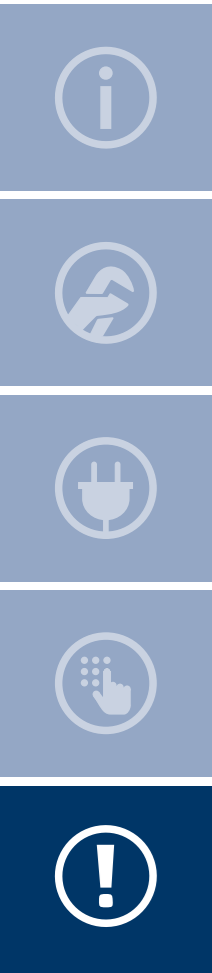

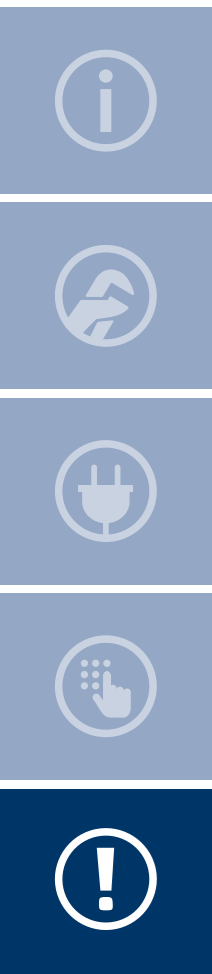

7

7

22

1 2 3 4 5 6 7

[net.grundfos.com/qr/i/98880508](https://net.grundfos.com/qr/i/98880508)

23

be think innovate

---

98501666 0517

ECM: 1203706

**GRUNDFOS Holding A/S**  
Poul Due Jensens Vej 7  
DK-8850 Bjerringbro  
Tel: +45 87 50 14 00  
[www.grundfos.com](http://www.grundfos.com)

**GRUNDFOS** 

The name Grundfos, the Grundfos logo, and be think innovate are registered trademarks owned by Grundfos Holding A/S or Grundfos A/S, Denmark. All rights reserved worldwide.